

GA-7VASFS-FS
AMD Socket A Processor Motherboard

USER'S MANUAL

Pentium®4 Processor Motherboard

Rev. 0201

12ME-7VASFS-0201

Table of Content

Item Checklist	4
Chapter 1 Introduction	5
Features Summary	5
GA-7VASFS-FS Motherboard Layout	7
Block Diagram	8
Chapter 2 Hardware Installation Process	10
Step 1: Install the Central Processing Unit (CPU)	11
Step1-1: CPU Speed Setup	11
Step1-2: CPU Installation	12
Step1-3: CPU Heat Sink Installation	13
Step 2: Install memory modules	14
Step 3: Install expansion cards	16
Step 4: Connect ribbon cables, cabinet wires, and power supply	17
Step 4-1: I/O Back Panel Introduction	17
Step 4-2: Connectors & Jumper Setting Introduction	19
Chapter 3 BIOS Setup	31
The Main Menu (For example: BIOS Ver. : D5)	32
Standard CMOS Features	34
Advanced BIOS Features	37
Integrated Peripherals	39
Power Management Setup	42

PnP/PCI Configurations	44
PC Health Status	45
Frequency/Voltage Control	46
Load Fail-Safe Defaults	47
Load Optimized Defaults	48
Set Supervisor/User Password	49
Save & Exit Setup	50
Exit Without Saving	51



Computer motherboards and expansion cards contain very delicate Integrated Circuit (IC) chips. To protect them against damage from static electricity, you should follow some precautions whenever you work on your computer.

1. Unplug your computer when working on the inside.
2. Use a grounded wrist strap before handling computer components. If you do not have one, touch both of your hands to a safely grounded object or to a metal object, such as the power supply case.
3. Hold components by the edges and try not touch the IC chips, leads or connectors, or other components.
4. Place components on a grounded antistatic pad or on the bag that came with the components whenever the components are separated from the system.
5. Ensure that the ATX power supply is switched off before you plug in or remove the ATX power connector on the motherboard.

Installing the motherboard to the chassis...

If the motherboard has mounting holes, but they don't line up with the holes on the base and there are no slots to attach the spacers, do not become alarmed you can still attach the spacers to the mounting holes. Just cut the bottom portion of the spacers (the spacer may be a little hard to cut off, so be careful of your hands). In this way you can still attach the motherboard to the base without worrying about short circuits. Sometimes you may need to use the plastic springs to isolate the screw from the motherboard PCB surface, because the circuit wire may be near by the hole. Be careful, don't let the screw contact any printed circuit write or parts on the PCB that are near the fixing hole, otherwise it may damage the board or cause board malfunctioning.

Chapter 1 Introduction

Features Summary

Form Factor	<ul style="list-style-type: none"> • 30.4cm x 24.4cm ATX size form factor, 4 layers PCB.
CPU	<ul style="list-style-type: none"> • Socket A processor AMD Athlon™/Athlon™ XP/ Duron™ (K7) 128K L1 & 256K/64K L2 cache on die 266/333/400 MHz FSB and DDR bus speeds • Supports 1.4GHz and faster
Chipset	<ul style="list-style-type: none"> • VIA KT600 Memory/AGP/PCI Controller (PAC) • VIA VT8237 Integrated Peripheral Controller (PSIPC)
Memory	<ul style="list-style-type: none"> • 3 184-pin DDR sockets • Supports DDR DRAM PC1600/PC2100/PC2700/PC3200^{<Note 2>} • Supports up to 1.5GB DDR (Max) • Supports only 2.5V DDR DIMM
I/O Control	<ul style="list-style-type: none"> • IT8705
Slots	<ul style="list-style-type: none"> • 1 AGP slot 4X (1.5V) / 8X(0.8V) device support • 5 PCI slot supports 33MHz & PCI 2.2 compliant
On-Board IDE	<ul style="list-style-type: none"> • 2 IDE bus master (UDMA33/ATA66/ATA100) IDE ports for up to 4 ATAPI devices • Supports PIO mode3,4 (UDMA 33/ATA66/ATA100) IDE & ATAPI CD-ROM
On-Board Peripherals	<ul style="list-style-type: none"> • 1 Floppy port supports 2 FDD with 360K, 720K, 1.2M, 1.44M and 2.88M bytes. • 1 Parallel port supports Normal/EPP/ECP mode • 1 Serial port (COMA), 1 SPDIF port, COMB on Board • 2 IEEE 1394 port • 8 USB 2.0/1.1 ports (4 x Rear, 4 xFront by cable) • 1 Front Audio Connector • 2 Serial ATA Connector

to be continued.....

Hardware Monitor	<ul style="list-style-type: none"> • CPU/Power/System Fan Revolution detect • CPU/Power/System Fan Fail Warning • CPU Overheat Warning • System Voltage Detect
On-Board Sound	<ul style="list-style-type: none"> • Realtek ALC655 CODEC • Line Out / 2 front speaker • Line In / 2 rear speaker(by s/w switch) • Mic In / center& subwoofer(by s/w switch) • AUX_In
On-Board LAN	<ul style="list-style-type: none"> • Build in RTL8101L Chipset
On-Board IEEE1394	<ul style="list-style-type: none"> • VT6307
PS/2 Connector	<ul style="list-style-type: none"> • PS/2 Keyboard interface and PS/2 Mouse interface
BIOS	<ul style="list-style-type: none"> • Licensed AWARD BIOS • Supports Q-Flash
Additional Features	<ul style="list-style-type: none"> • PS/2 Keyboard power on by password • PS/2 Mouse power on • STR(Suspend-To-RAM) • AC Recovery • USB KB/Mouse wake up from S3 • Acoustic Management for hard drive and optical drive



Please set the CPU host frequency in accordance with your processor's specifications. We don't recommend you to set the system bus frequency over the CPU's specification because these specific bus frequencies are not the standard specifications for CPU, chipset and most of the peripherals. Whether your system can run under these specific bus frequencies properly will depend on your hardware configurations, including CPU, Chipsets, SDRAM, Cards...etc.

GA-7VASFS-FS Motherboard Layout

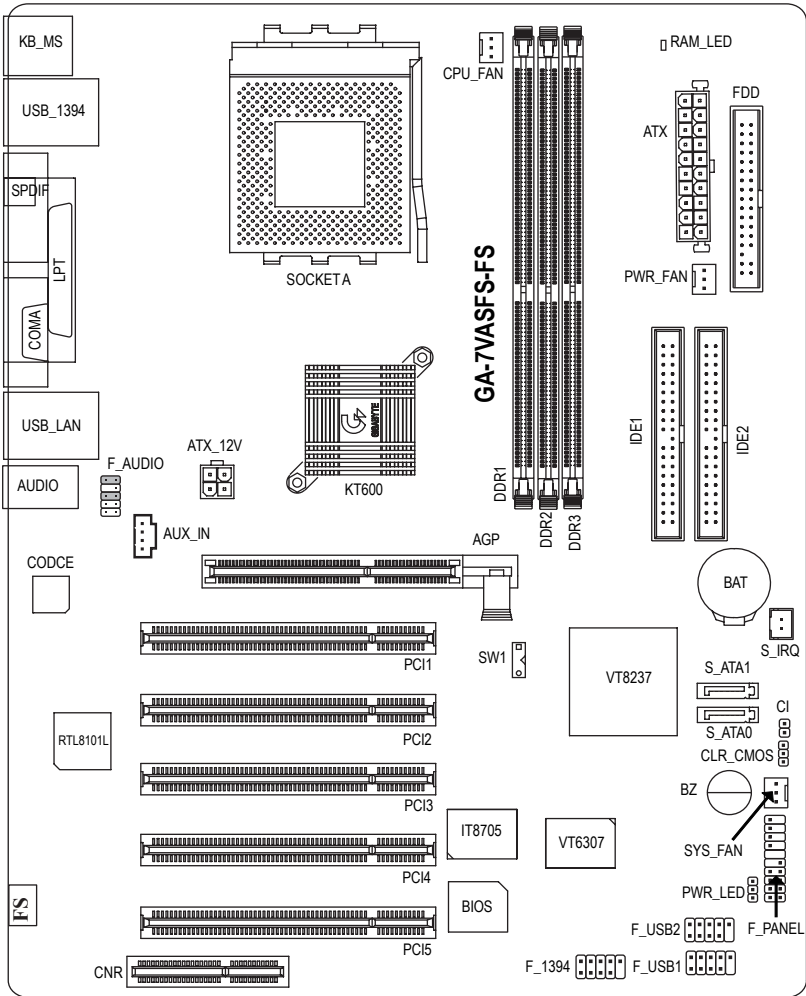

Block Diagram

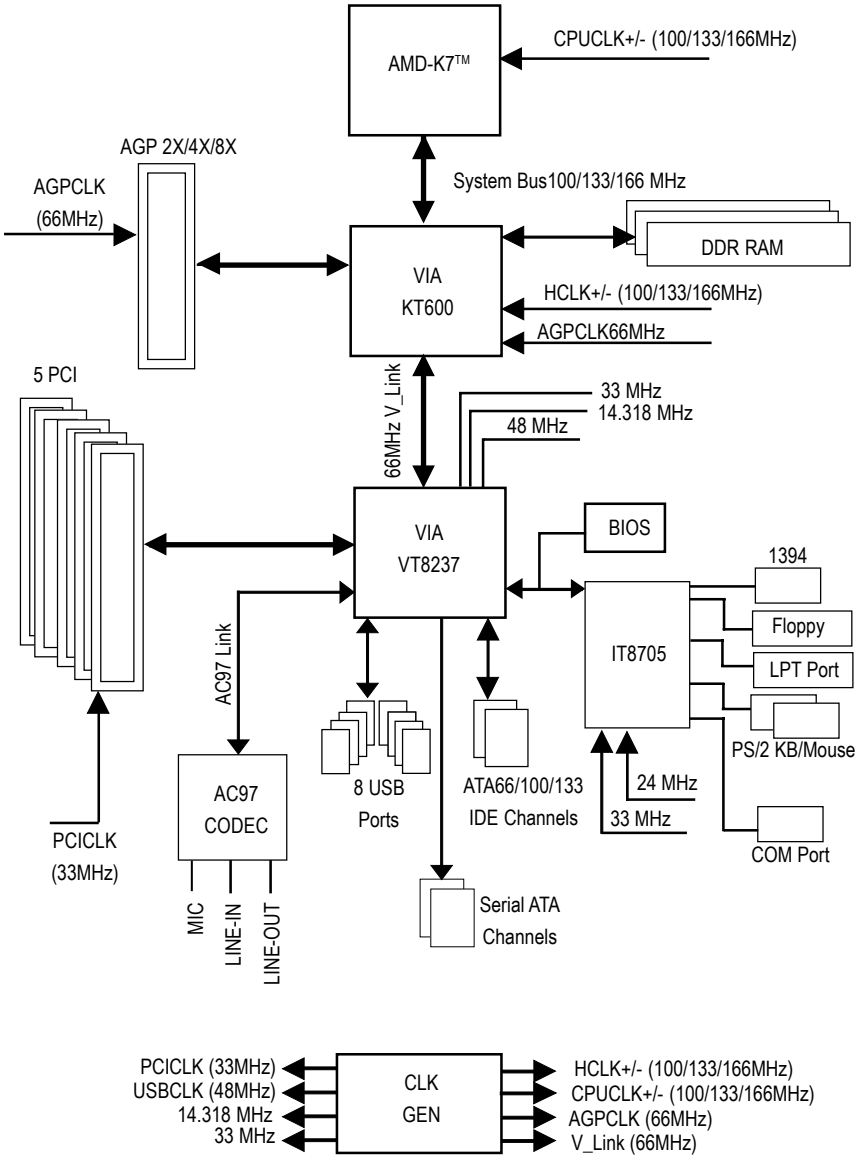

Chapter 2 Hardware Installation Process

To set up your computer, you must complete the following steps:

- Step 1- Set system Switch (SW1)
- Step 2- Install the Central Processing Unit (CPU)
- Step 3- Install memory modules
- Step 4- Install expansion cards
- Step 5- Connect ribbon cables, cabinet wires, and power supply

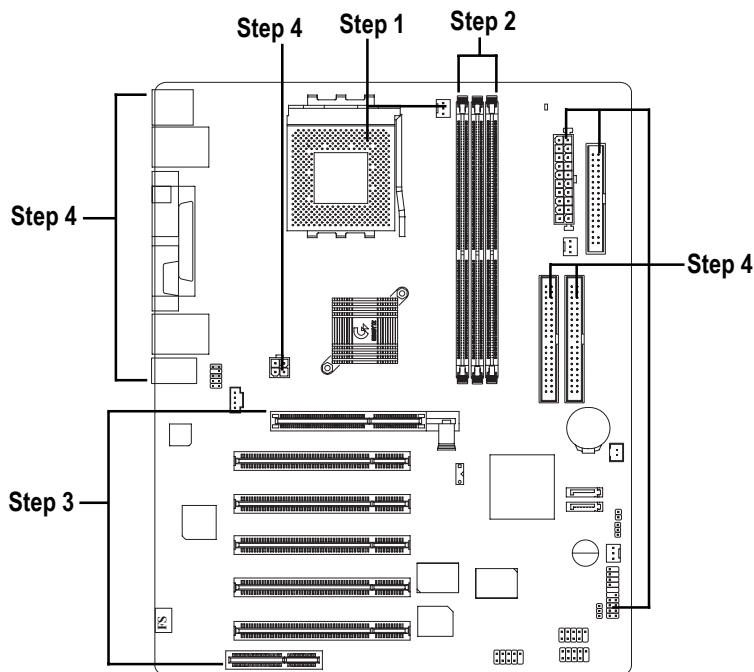

Congratulations you have accomplished the hardware installation!

Turn on the power supply or connect the power cable to the power outlet. Continue with the BIOS/ software installation.

Step 1: Install the Central Processing Unit (CPU)

Step1-1: CPU Speed Setup

The system bus frequency can be switched at 100/133/166/200MHz by adjusting system switch (SW1). (The internal frequency depend on CPU.)

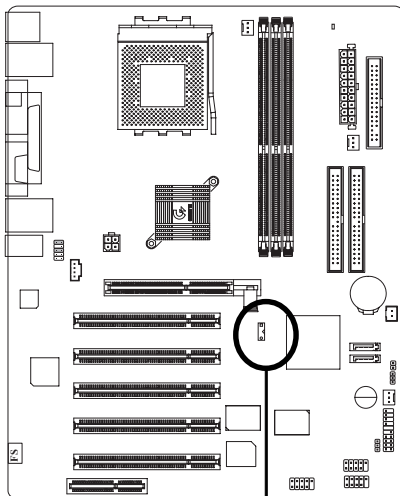

O: ON / X :OFF

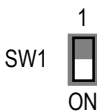

Default Setting: 100MHz

SW1	CPU CLOCK	
		100MHz
1	ON	OFF



100MHz : Fix FSB 200MHz CPU
 Auto : Support FSB 266/333/400 MHz CPU
 You must set SW1 to 100MHz when you used FSB 200MHz CPU.

Step1-2: CPU Installation



Before installing the processor, adhere to the following warning:

1. Please make sure the CPU type is supported by the motherboard.
2. If you do not match the CPU socket Pin 1 and CPU cut edge well, it will cause improper installation. Please change the insert orientation.



CPU Top View

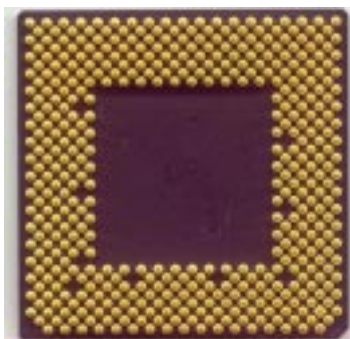

CPU Bottom View

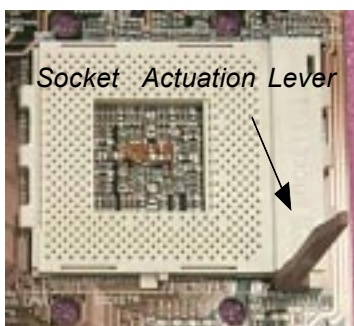

1. Pull up the CPU socket lever and up to 90-degree angle.

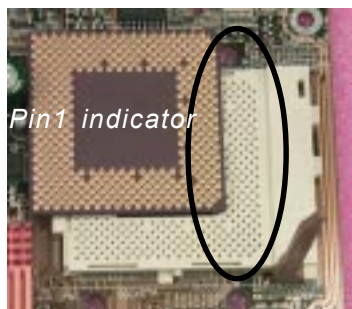

2. Locate Pin 1 in the socket and look for a (golden) cut edge on the CPU upper corner. Then insert the CPU into the socket.

Step1-3: CPU Heat Sink Installation



Before installing the CPU Heat Sink , adhere to the following warning:

1. Please use AMD approved cooling fan.
2. We recommend you to apply the thermal paste to provide better heat conduction between your CPU and Cooling Fan.
3. Make sure the CPU fan power cable is plugged in to the CPU fan connector, this completes the installation.
Please refer to CPU cooling fan user's manual for more detail installation procedure.



1. Press down the CPU socket lever and finish CPU installation.



2. Use qualified fan approved by AMD.

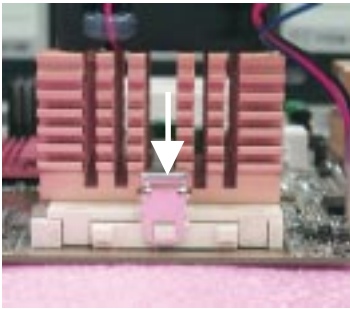

3. Fasten the heatsink supporting-base onto the CPU socket on the main-board.



4. Make sure the CPU fan is plugged to the CPU fan connector, than install complete.

Step 2: Install memory modules



Before installing the memory modules, adhere to the following warning:

1. When RAM_LED is ON, do not install / remove DIMM from socket.
2. Please note that the DIMM module can only fit in one direction due to the one notch. Wrong orientation will cause improper installation. Please change the insert orientation.

The motherboard has 3 dual inline memory module(DIMM) sockets. The BIOS will automatically detects memory type and size. To install the memory module, just push it vertically into the DIMM Slot. The DIMM module can only fit in one direction due to the notch. Memory size can vary between sockets.

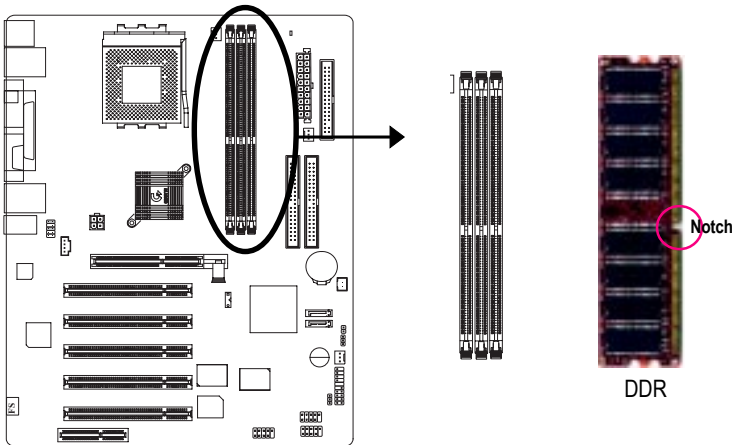

Support Unbuffered DDR DIMM Sizes type:

64 Mbit (2Mx8x4 banks)	64 Mbit (1Mx16x4 banks)	128 Mbit(4Mx8x4 banks)
128 Mbit(2Mx16x4 banks)	256 Mbit(8Mx8x4 banks)	256 Mbit(4Mx16x4 banks)
512 Mbit(16Mx8x4 banks)	512 Mbit(8Mx16x4 banks)	



Only two double side DDR 400 memory modules are allowed to be used!

1. The DIMM slot has a notch, so the DIMM memory module can only fit in one direction.

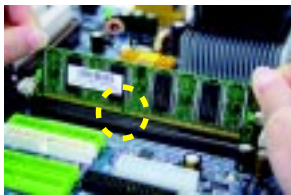

2. Insert the DIMM memory module vertically into the DIMM slot. Then push it down.



3. Close the plastic clip at both edges of the DIMM slots to lock the DIMM module. Reverse the installation steps when you wish to remove the DIMM module.



DDR Introduction

Established on the existing SDRAM infrastructure, DDR (Double Data Rate) memory is a high performance and cost-effective solution that allows easy adoption for memory vendors, OEMs, and system integrators.

DDR memory is a great evolutionary solution for the PC industry that builds on the existing SDRAM architecture, yet make the awesome advances in solving the system performance bottleneck by doubling the memory bandwidth. Nowadays, with the highest bandwidth of 3.2GB/s of DDR400 memory and complete line of DDR400/333/266/200 memory solutions, DDR memory is the best choice for building high performance and low latency DRAM subsystem that are suitable for servers, workstations, and full range of desktop PCs.

Step 3: Install expansion cards

1. Read the related expansion card's instruction document before install the expansion card into the computer.
2. Remove your computer's chassis cover, necessary screws and slot bracket from the computer.
3. Press the expansion card firmly into expansion slot in motherboard.
4. Be sure the metal contacts on the card are indeed seated in the slot.
5. Replace the screw to secure the slot bracket of the expansion card.
6. Replace your computer's chassis cover.
7. Power on the computer, if necessary, setup BIOS utility of expansion card from BIOS.
8. Install related driver from the operating system.



AGP Card



Please carefully pull out the small white- drawbar at the end of the AGP slot when you try to install/ Uninstall the AGP card. Please align the AGP card to the onboard AGP slot and press firmly down on the slot .Make sure your AGP card is locked by the small white- drawbar.

Issues To Beware Of When Installing CNR

Please use standard CNR card like the one in order to avoid mechanical problem.



Standard CNR Card

Step 4: Connect ribbon cables, cabinet wires, and power supply

Step 4-1: I/O Back Panel Introduction

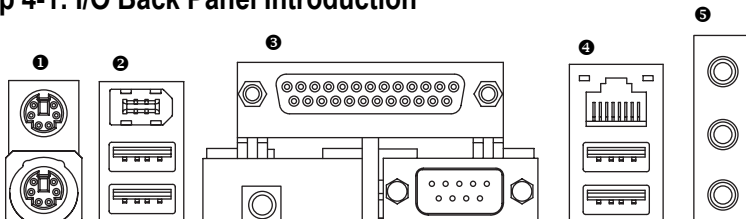

❶ PS/2 Keyboard and PS/2 Mouse Connector



PS/2 Mouse Connector
(6 pin Female)

PS/2 Keyboard Connector
(6 pin Female)

- This connector supports standard PS/2 keyboard and PS/2 mouse.

❷ IEEE 1394 and USB Connector

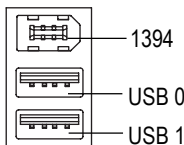

1394

USB 0

USB 1

- This connector supports IEEE 1394 and USB devices.

❸ Parallel Port, Serial Port and SPDIF Port (LPT/COMA/SPDIF)

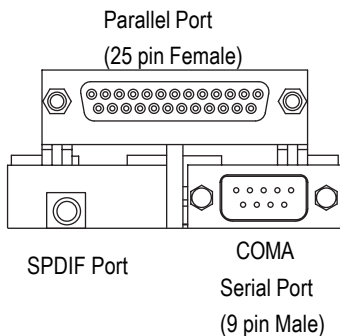

Parallel Port
(25 pin Female)

SPDIF Port

COMA
Serial Port
(9 pin Male)

- This connector supports 1 standard COM port, 1 Parallel port and 1 SPDIF port. Device like printer can be connected to Parallel port; mouse and modem etc can be connected to Serial ports.

The SPDIF output is capable of providing digital audio to external speakers or compressed AC3 data to an external Dolby Digital Decoder. Use this feature only when your stereo system has digital input function.

4 USB & LAN Connector

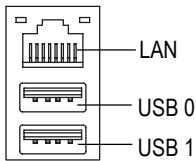

- Before you connect your device(s) into USB connector(s), please make sure your device(s) such as USB keyboard, mouse, scanner, zip, speaker, etc. Have a standard USB interface. Also make sure your OS supports USB controller.
If your OS does not support USB controller, please contact OS vendor for possible patch or driver upgrade. For more information please contact your OS or device(s) vendors.

5 Audio Connectors

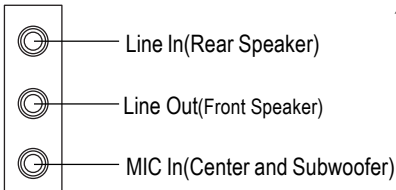

- After install onboard audio driver, you may connect speaker to Line Out jack, micro phone to MIC In jack.
Device like CD-ROM, walkman etc can be connected to Line-In jack.

Please note:

You are able to use 2-/4-/6- channel audio feature by S/W selection.

If you want to enable 6-channel function, you have 2 choose for hardware connection.

Method1:

Connect "Front Speaker" to "Line Out"

Connect "Rear Speaker" to "Line In"

Connect "Center and Subwoofer" to "MIC Out".

Step 4-2: Connectors & Jumper Setting Introduction

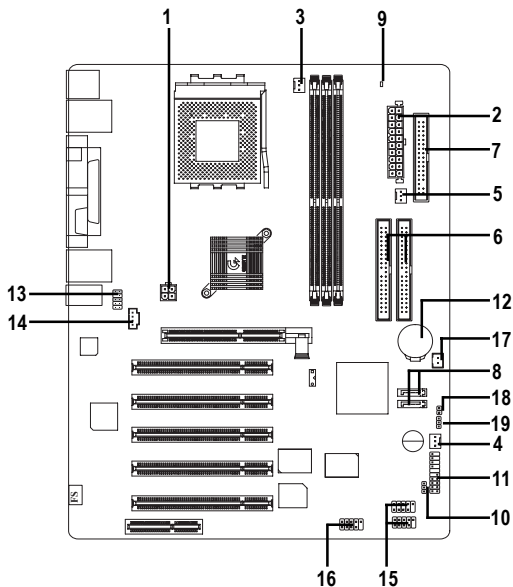

1) ATX_12V	12) BAT
2) ATX	13) F_AUDIO
3) CPU_FAN	14) AUX_IN
4) SYS_FAN	15) F_USB1/F_USB2
5) PWR_FAN	16) F_1394
6) IDE1/IDE2	17) S_IRQ
7) FDD	18) CI
8) S_ATA0/S_ATA1	19) CLR_CMOS
9) RAM_LED	
10) PWR_LED	
11) F_PANEL	

1) ATX_12V (+12V Power Connector)

This connector (ATX_12V) supplies the CPU operation voltage (Vcore). If this "ATX_12V connector" is not connected, system cannot boot.

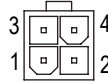
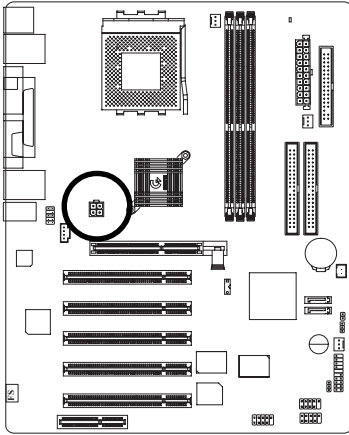

Pin No.	Definition
1	GND
2	GND
3	+12V
4	+12V

2) ATX (ATX Power)

AC power cord should only be connected to your power supply unit after ATX power cable and other related devices are firmly connected to the mainboard.

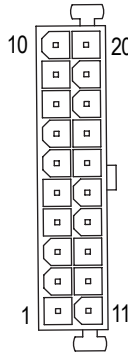
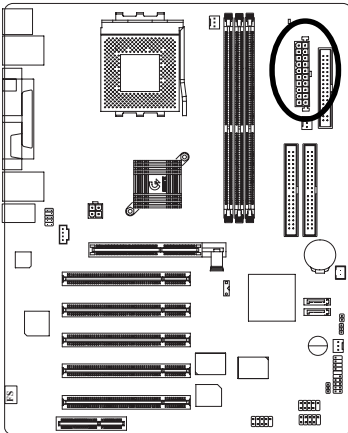

Pin No.	Definition
1	3.3V
2	3.3V
3	GND
4	VCC
5	GND
6	VCC
7	GND
8	Power Good
9	5V SB(stand by +5V)
10	+12V
11	3.3V
12	-12V
13	GND
14	PS_ON(softOn/Off)
15	GND
16	GND
17	GND
18	-5V
19	VCC
20	VCC

3) CPU_FAN (CPU FAN Connector)

Please note, a proper installation of the CPU cooler is essential to prevent the CPU from running under abnormal condition or damaged by overheating. The CPU fan connector supports Max. current up to 600 mA.

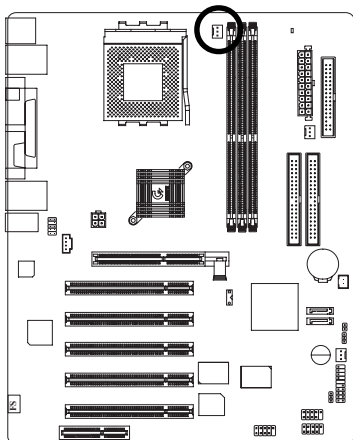

Pin No.	Definition
1	GND
2	+12V
3	Sense

4) SYS_FAN (System FAN Connector)

This connector allows you to link with the cooling fan on the system case to lower the system temperature.

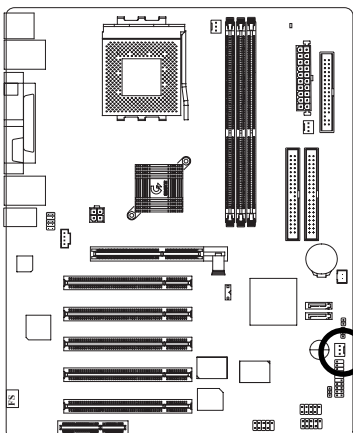

Pin No.	Definition
1	GND
2	+12V
3	Sense

5) PWR_FAN (Power Fan Connector)

This connector allows you to link with the cooling fan on the system case to lower the system temperature.

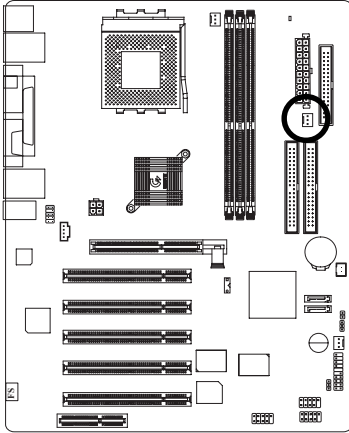

Pin No.	Definition
1	GND
2	+12V
3	Sense

6) IDE1/ IDE2 (IDE1/IDE2 Connector)

Please connect first harddisk to IDE1 and connect CDROM to IDE2. The red stripe of the ribbon cable must be the same side with the Pin1.

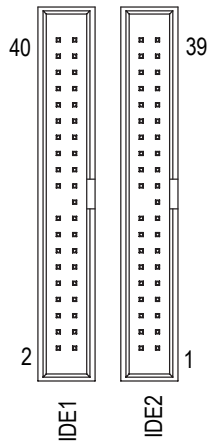
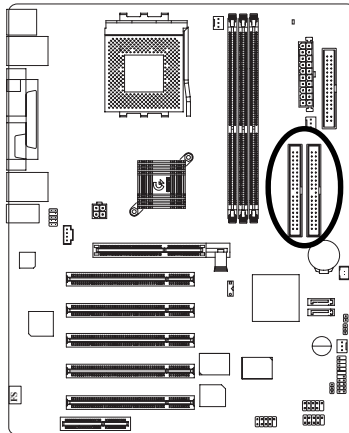

7) FDD (Floppy Connector)

Please connect the floppy drive ribbon cables to FDD. It supports 360K,720K,1.2M,1.44M and 2.88Mbytes floppy disk types. The red stripe of the ribbon cable must be the same side with the Pin1.

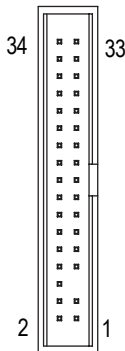
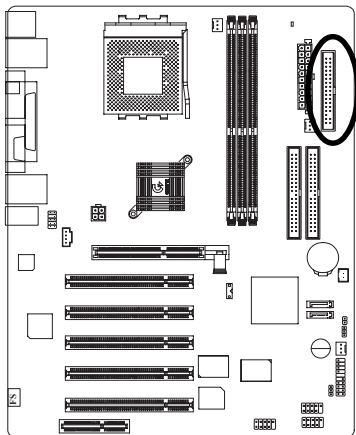

8) S_ATA/S_ATA1 (Serial ATA Connector)

You can connect the Serial ATA device to this connector, it provides you high speed transfer rates (150MB/sec).If you wish to use SATA0 and SATA1, please Enable " OnChip Serial ATA " item.

Then, install the correct driver to have proper operation. For details, please refer to the "VT8237_SATA_Manual.pdf" at "<http://www.gigabyte.com.tw>"

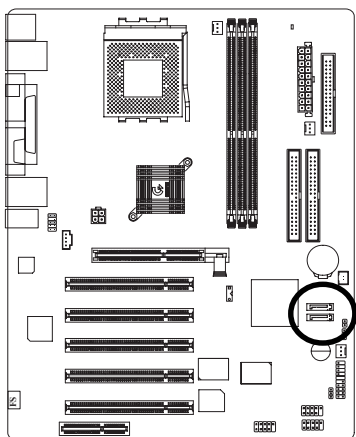

Pin No.	Definition
1	GND
2	TXP
3	TXN
4	GND
5	RXN
6	RXP
7	GND

9) RAM_LED

Do not remove memory modules while DIMM LED is on. It might cause short or other unexpected damages due to the 2.5V stand by voltage. Remove memory modules only when AC Power cord is disconnected.

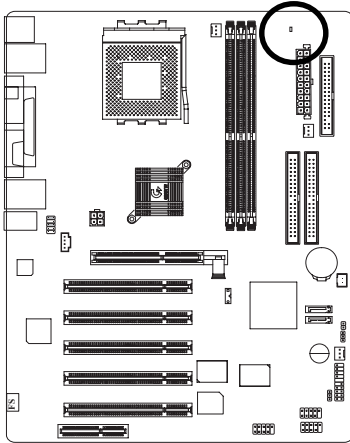

10) PWR_LED

PWR_LED is connect with the system power indicator to indicate whether the system is on/off. It will blink when the system enters suspend mode. If you use dual color LED, power LED will turn to another color.

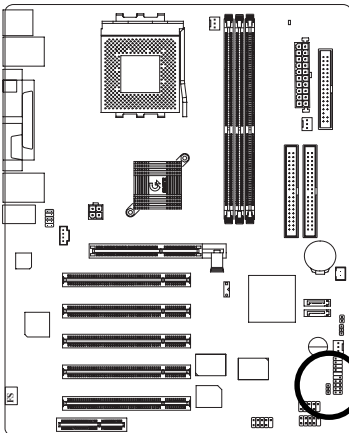

Pin No.	Definition
1	MPD+
2	MPD-
3	MPD-

11) F_PANEL (2x10 pins connector)

Please connect the power LED, PC peaker, reset switch and power switch etc of your chassis front panel to the F_PANEL connector according to the pin assignment above.

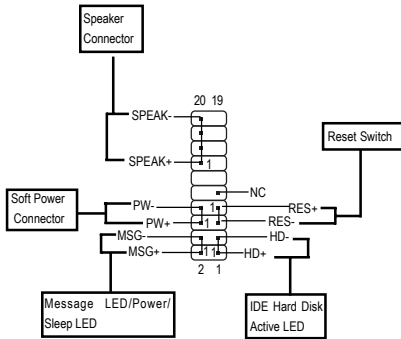
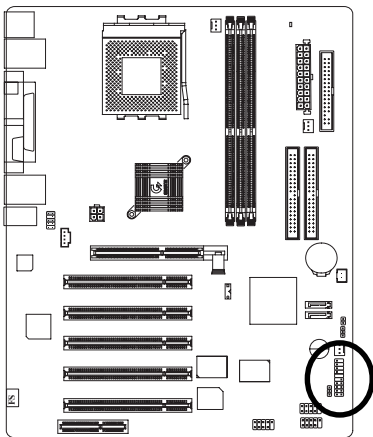

HD (IDE Hard Disk Active LED) (Blue)	Pin 1: LED anode(+) Pin 2: LED cathode(-)
SPK (Speaker Connector) (Amber)	Pin 1: VCC(+) Pin 2- Pin 3: NC Pin 4: Data(-)
RES (Reset Switch) (Green)	Open: Normal Operation Close: Reset Hardware System
PW (Soft Power Connector) (Red)	Open: Normal Operation Close: Power On/Off
MSG(Message LED/Power/ Sleep LED)(Yellow)	Pin 1: LED anode(+) Pin 2: LED cathode(-)
NC(Purple)	NC

12) BAT (Battery)

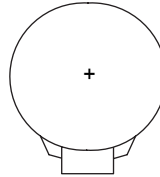
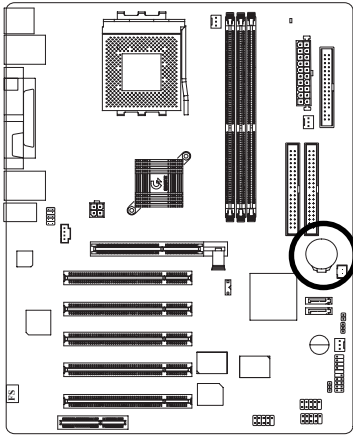

CAUTION

- ❖ Danger of explosion if battery is incorrectly replaced.
- ❖ Replace only with the same or equivalent type recommended by the manufacturer.
- ❖ Dispose of used batteries according to the manufacturer's instructions.

If you want to erase CMOS...

1. Turn OFF the computer and unplug the power cord.
2. Remove the battery, wait for 30 second.
3. Re-install the battery.
4. Plug the power cord and turn ON the computer.

13) F_AUDIO (F_AUDIO Connector)

If you want to use Front Audio connector, you must remove 5-6, 9-10 Jumper. In order to utilize the front audio header, your chassis must have front audio connector. Also please make sure the pin assignment on the cable is the same as the pin assignment on the MB header. To find out if the chassis you are buying support front audio connector, please contact your dealer. Please note, you can have the alternative of using front audio connector or of using rear audio connector to play sound.

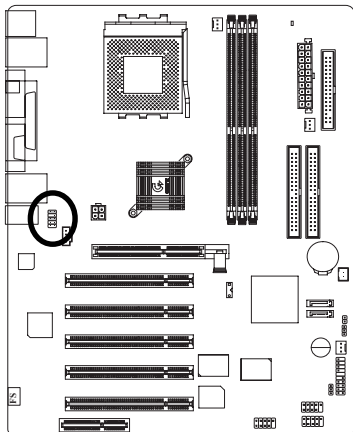

Pin No.	Definition
1	MIC
2	GND
3	REF
4	POWER
5	FrontAudio (R)
6	RearAudio (R)
7	Reserved
8	No Pin
9	FrontAudio (L)
10	RearAudio (L)

14) AUX_IN (AUX In Connector)

Connect other device(such as PCI TV Tunner audio out)to the connector.

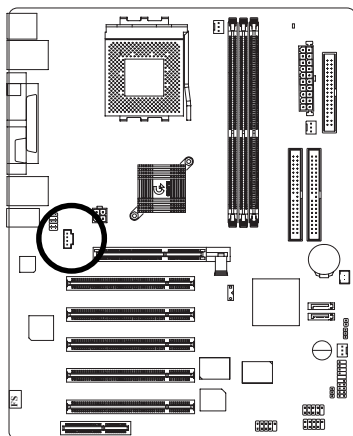

Pin No.	Definition
1	AUX-L
2	GND
3	GND
4	AUX_R

15) F_USB1 / F_USB2 (Front USB Connector, Yellow)

Be careful with the polarity of the front USB connector. Check the pin assignment while you connect the front USB cable. Please contact your nearest dealer for optional front USB cable.

Be careful with the polarity of the F_USB connector. Check the pin assignment carefully while you connect the F_USB cable, incorrect connection between the cable and connector will make the device unable to work or even damage it. For optional F_USB cable, please contact your local dealer.

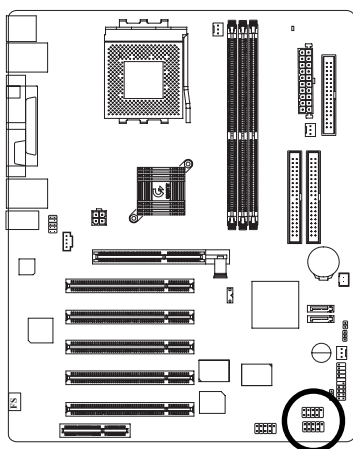

Pin No.	Definition
1	Power
2	Power
3	USB DX-
4	USB Dy-
5	USB DX+
6	USB Dy+
7	GND
8	GND
9	No Pin
10	NC

16) F_1394 (IEEE 1394 Connector)

Please Note: Serial interface standard set by Institute of Electrical and Electronics Engineers, which has features like high speed, high bandwidth and hot plug.

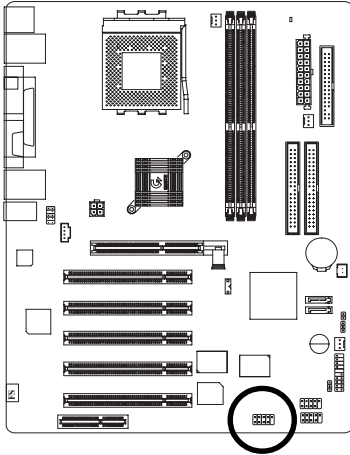

Pin No.	Definition
1	NDCDB-
2	NSINB
3	NSOUTB
4	NDTRB-
5	GND
6	NDSRB-
7	NRTSB-
8	NCTSB-
9	NRIB-
10	No Pin

17) S_IRQ (Serial IRQ Connector)

This connector is for special design, for example: PCMCIA add on card.

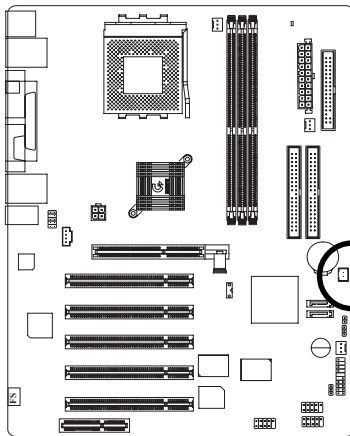

Pin No.	Definition
1	Signal
2	GND

18) CI (CASE OPEN)

This 2 pin connector allows your system to enable or disable the "case open" item in BIOS if the system case begin remove.

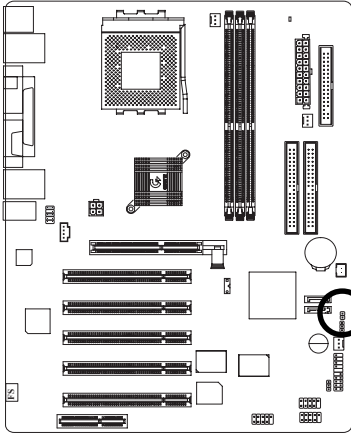

1 

Pin No.	Definition
1	Signal
2	GND

19) CLR_CMOS (Clear CMOS jumper)

You may clear the CMOS data to its default values by this jumper. Default doesn't include the "Shunter" to prevent from improper use this jumper. To Clear CMOS, temporarily short 1-2 pin.

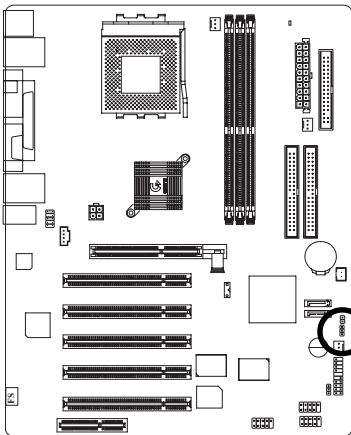

1 

1-2 close: Enable

1 

2-3 open: Normal (Default)

Chapter 3 BIOS Setup

BIOS Setup is an overview of the BIOS Setup Program. The program that allows users to modify the basic system configuration. This type of information is stored in battery-backed CMOS RAM so that it retains the Setup information when the power is turned off.

ENTERING SETUP

Powering ON the computer and pressing immediately will allow you to enter Setup. If you require more advanced BIOS settings, please go to "Advanced BIOS" setting menu. To enter Advanced BIOS setting menu, press "Ctrl+F1" key on the BIOS screen.

CONTROL KEYS

<↑>	Move to previous item
<↓>	Move to next item
<←>	Move to the item in the left hand
<→>	Move to the item in the right hand
Enter	Select item
<Esc>	Main Menu - Quit and not save changes into CMOS Status Page Setup Menu and Option Page Setup Menu - Exit current page and return to Main Menu
<+/PgUp>	Increase the numeric value or make changes
<-/PgDn>	Decrease the numeric value or make changes
<F1>	General help, only for Status Page Setup Menu and Option Page Setup Menu
<F2>	Item Help
<F3>	Reserved
<F4>	Reserved
<F5>	Restore the previous CMOS value from CMOS, only for Option Page Setup Menu
<F6>	Load the file-safe default CMOS value from BIOS default table
<F7>	Load the Optimized Defaults
<F8>	Q-Flash function
<F9>	System Information
<F10>	Save all the CMOS changes, only for Main Menu

GETTING HELP

Main Menu

The on-line description of the highlighted setup function is displayed at the bottom of the screen.

Status Page Setup Menu / Option Page Setup Menu

Press F1 to pop up a small help window that describes the appropriate keys to use and the possible selections for the highlighted item. To exit the Help Window press <Esc>.

The Main Menu (For example: BIOS Ver. : D5)

Once you enter Award BIOS CMOS Setup Utility, the Main Menu (Figure 1) will appear on the screen. The Main Menu allows you to select from eight setup functions and two exit choices. Use arrow keys to select among the items and press <Enter> to accept or enter the sub-menu.

CMOS Setup Utility-Copyright (C) 1984-2003 Award Software

▶Standard CMOS Features	Load Fail-Safe Defaults
▶Advanced BIOS Features	Load Optimized Defaults
▶Integrated Peripherals	Set Supervisor Password
▶Power Management Setup	Set User Password
▶PnP/PCI Configurations	Save & Exit Setup
▶PC Health Status	Exit Without Saving
▶Frequency/Voltage Control	
ESC:Quit	↑↓→←:Select Item
F8: Q-Flash	F10:Save & Exit Setup
Time, Date, Hard Disk Type...	

Figure 1: Main Menu



If you can't find the setting you want, please press "Ctrl+F1" to search the advanced option widden.

- **Standard CMOS Features**
This setup page includes all the items in standard compatible BIOS.
- **Advanced BIOS Features**
This setup page includes all the items of Award special enhanced features.

- **Integrated Peripherals**
This setup page includes all onboard peripherals.
- **Power Management Setup**
This setup page includes all the items of Green function features.
- **PnP/PCI Configurations**
This setup page includes all the configurations of PCI & PnP ISA resources.
- **PC Health Status**
This setup page is the System auto detect Temperature, voltage, fan, speed.
- **Frequency/Voltage Control**
This setup page is control CPU's clock and frequency ratio.
- **Load Fail-Safe Defaults**
Fail-Safe Defaults indicates the value of the system parameters which the system would be in safe configuration.
- **Load Optimized Defaults**
Optimized Defaults indicates the value of the system parameters which the system would be in best performance configuration.
- **Set Supervisor password**
Change, set, or disable password. It allows you to limit access to the system and Setup, or just to Setup.
- **Set User password**
Change, set, or disable password. It allows you to limit access to the system.
- **Save & Exit Setup**
Save CMOS value settings to CMOS and exit setup.
- **Exit Without Saving**
Abandon all CMOS value changes and exit setup.

Standard CMOS Features

CMOS Setup Utility-Copyright (C) 1984-2003 Award Software

Standard CMOS Features

Date (mm:dd:yy)	Tue, Aug 13 2002	Item Help
Time (hh:mm:ss)	22:31:24	Menu Level ►
►IDE Primary Master	[None]	Change the day, month, year
►IDE Primary Slave	[None]	
►IDE Secondary Master	[None]	<Week>
►IDE Secondary Slave	[None]	Sun. to Sat.
►Acoustic Management	[Disabled]	
Drive A	[1.44M, 3.5 in.]	<Month>
Drive B	[None]	Jan. to Dec.
Floppy 3 Mode Support	[Disabled]	
		<Day>
Halt On	[All, But Keyboard]	1 to 31 (or maximum allowed in the month)
Base Memory	640K	
Extended Memory	130048K	<Year>
Total Memory	131072K	1999 to 2098
↑↓→←: Move Enter:Select +/-/PU/PD:Value F10:Save ESC:Exit F1:General Help F5:Previous Values F6:Fail-Safe Defaults F7:Optimized Defaults		

Figure 2: Standard CMOS Features

☞ Date

The date format is <week>, <month>, <day>, <year>.

- Week The week, from Sun to Sat, determined by the BIOS and is display only
- Month The month, Jan. Through Dec.
- Day The day, from 1 to 31 (or the maximum allowed in the month)
- Year The year, from 1999 through 2098

☞ Time

The times format in <hour> <minute> <second>. The time is calculated base on the 24-hour military-time clock. For example, 1 p.m. is 13:00:00.

☞ **IDE Primary Master, Slave / IDE Secondary Master, Slave**

The category identifies the types of hard disk from drive C to F that has been installed in the computer. There are two types: auto type, and manual type. Manual type is user-definable; Auto type which will automatically detect HDD type.

Note that the specifications of your drive must match with the drive table. The hard disk will not work properly if you enter improper information for this category.

If you select User Type, related information will be asked to enter to the following items. Enter the information directly from the keyboard and press <Enter>. Such information should be provided in the documentation form your hard disk vendor or the system manufacturer.

- | | |
|-------------|---------------------|
| ▶▶ CYLS. | Number of cylinders |
| ▶▶ HEADS | Number of heads |
| ▶▶ PRECOMP | Write precomp |
| ▶▶ LANDZONE | Landing zone |
| ▶▶ SECTORS | Number of sectors |

If a hard disk has not been installed select NONE and press <Enter>.

☞ **Acoustic Management**

As well as hard disk and optical data drives such as CD-ROM, CD-RW and DVD are also responsible for generating noise in the PC. Therefore the BIOS support the acoustic management feature to reduce the noise. In the Standard CMOS Features please select the IDE drive, which should be support the Acoustic management and press Enter. When the IDE device can support the acoustic management then you can see this option in the BIOS setup. The following options are available:

- ▶▶ Hard Drive Disabled: full hard disk performance with maximum noise generation (default)
Silent: lower hard disk performance with minimum noise generation
- ▶▶ Optical Drive Disabled: the device can rotate at maximum speed with maximum noise generation
Medium: the device can rotate at no higher than medium speed with medium noise generation (default)
Silent: the device can rotate at minimum speed only with minimum noise generation

For optimal performance for hard drive and optical drive please disabled the acoustic management.

☞ **Drive A / Drive B**

The category identifies the types of floppy disk drive A or drive B that has been installed in the computer.

- ▶▶ None No floppy drive installed
- ▶▶ 360K, 5.25 in. 5.25 inch PC-type standard drive; 360K byte capacity.
- ▶▶ 1.2M, 5.25 in. 5.25 inch AT-type high-density drive; 1.2M byte capacity
(3.5 inch when 3 Mode is Enabled).
- ▶▶ 720K, 3.5 in. 3.5 inch double-sided drive; 720K byte capacity
- ▶▶ 1.44M, 3.5 in. 3.5 inch double-sided drive; 1.44M byte capacity.
- ▶▶ 2.88M, 3.5 in. 3.5 inch double-sided drive; 2.88M byte capacity.

☞ **Floppy 3 Mode Support (for Japan Area)**

- ▶▶ Disabled Normal Floppy Drive. (Default value)
- ▶▶ Drive A Drive A is 3 mode Floppy Drive.
- ▶▶ Drive B Drive B is 3 mode Floppy Drive.
- ▶▶ Both Drive A & B are 3 mode Floppy Drives.

☞ **Halt on**

The category determines whether the computer will stop if an error is detected during power up.

- ▶▶ NO Errors The system boot will not stop for any error that may be detected and you will be prompted.
- ▶▶ All Errors Whenever the BIOS detects a non-fatal error the system will be stopped.
- ▶▶ All, But Keyboard The system boot will not stop for a keyboard error; it will stop for all other errors. (Default value)
- ▶▶ All, But Diskette The system boot will not stop for a disk error; it will stop for all other errors.
- ▶▶ All, But Disk/Key The system boot will not stop for a keyboard or disk error; it will stop for all other errors.

☞ **Memory**

The category is display-only which is determined by POST (Power On Self Test) of the BIOS.

Base Memory

The POST of the BIOS will determine the amount of base (or conventional) memory installed in the system.

The value of the base memory is typically 512 K for systems with 512 K memory installed on the motherboard, or 640 K for systems with 640 K or more memory installed on the motherboard.

Extended Memory

The BIOS determines how much extended memory is present during the POST.

This is the amount of memory located above 1 MB in the CPU's memory address map.

Advanced BIOS Features

CMOS Setup Utility-Copyright (C) 1984-2003 Award Software

Advanced BIOS Features

First Boot Device	[CDROM]	Item Help
Second Boot Device	[Floppy]	Menu Level ►
Third Boot Device	[HDD-0]	Select Boot Device
Password Check	[Setup]	priority
Full Screen LOGO Show	[Enabled]	[Floppy]
		Boot from floppy
		[LS120]
		Boot from LS120
		[HDD-0]
		Boot from First HDD
		[HDD-1]
		Boot from second HDD
↑↓→←: Move Enter:Select +/-/PU/PD:Value F10:Save ESC:Exit F1:General Help F5:Previous Values F6:Fail-Safe Defaults F7:Optimized Defaults		

Figure 3: Advanced BIOS Features

☞ **First / Second / Third Boot Device**

- ▶▶ Floppy Select your boot device priority by Floppy.
- ▶▶ LS120 Select your boot device priority by LS120.
- ▶▶ HDD-0-3 Select your boot device priority by HDD-0-3.
- ▶▶ SCSI Select your boot device priority by SCSI.
- ▶▶ CDROM Select your boot device priority by CDROM.
- ▶▶ ZIP Select your boot device priority by ZIP.
- ▶▶ USB-FDD Select your boot device priority by USB-FDD.
- ▶▶ USB-ZIP Select your boot device priority by USB-ZIP.
- ▶▶ USB-CDROM Select your boot device priority by USB-CDROM.
- ▶▶ USB-HDD Select your boot device priority by USB-HDD.
- ▶▶ LAN Select your boot device priority by LAN.
- ▶▶ Disabled Select your boot device priority by Disabled.

☞ **Password Check**

- ▶▶ System The system will not boot and will not access to Setup page if the correct password is not entered at the prompt.
- ▶▶ Setup The system will boot but will not access to Setup page if the correct password is not entered at the prompt. (Default value)

☞ **Full Screen LOGO Show**

This feature allows you to show the company logo on the bootup screen.

- ▶▶ Disabled Shows the POST messages at boot.
- ▶▶ Enabled Shows the still image(LOGO) on the full screen at boot. (Default value)

Integrated Peripherals

CMOS Setup Utility-Copyright (C) 1984-2003 Award Software

Integrated Peripherals

OnChip IDE Channel0	[Enabled]	Item Help
OnChip IDE Channel1	[Enabled]	Menu Level ►
OnChip Serial ATA	[Enabled]	If a hard disk
AC97 Audio	[Auto]	controller card is
MC97 Modem	[Auto]	used, set at Disabled
USB 1.1 Controller	[Enabled]	
USB 2.0 Controller	[Enabled]	[Enabled]
USB Device Function	[Disabled]	Enable on-chip IDE
USB Keyboard Support	[Enabled]	Channel
USB Mouse Support	[Enabled]	
Onboard H/W LAN	[Enabled]	[Disabled]
Onboard H/W 1394	[Enabled]	Disable on-chip IDE
Onboard Serial Port 1	[3F8/IRQ4]	Channel
Onboard Parallel Port	[378/IRQ7]	
Parallel Port Mode	[EPP]	
↑↓→←: Move Enter:Select +/-/PU/PD:Value F10:Save ESC:Exit F1:General Help F5:Previous Values F6:Fail-Safe Defaults F7:Optimized Defaults		

Figure 4: Integrated Peripherals

☞ OnChip IDE Channel0

- ▶▶ Enabled Enable onboard channel0 IDE port. (Default value)
- ▶▶ Disabled Disable onboard channel0 IDE port.

☞ OnChip IDE Channel1

- ▶▶ Enabled Enable onboard channel1 IDE port. (Default value)
- ▶▶ Disabled Disable onboard channel1 IDE port.

☞ **OnChip Serial ATA**

- ▶▶ Disabled Disable VT8237 Serial ATA.
- ▶▶ Enabled Enable VT8237 Serial ATA support. (Default Value)

☞ **AC97 Audio**

- ▶▶ Auto Enable onboard AC'97 audio function. (Default Value)
- ▶▶ Disabled Disable this function.

☞ **MC97 Modem**

- ▶▶ Auto Enable onboard MC97 controller. (Default Value)
- ▶▶ Disabled Disable this function.

☞ **USB 1.1 Controller**

Disable this function if you are not using onboard USB 1.1 feature.

- ▶▶ Enabled Enable USB 1.1 Controller. (Default value)
- ▶▶ Disabled Disable USB 1.1 Controller.

☞ **USB 2.0 Controller**

Disable this function if you are not using onboard USB 2.0 feature.

- ▶▶ Enabled Enable USB 2.0 Controller. (Default value)
- ▶▶ Disabled Disable USB 2.0 Controller.

☞ **USB Device Function**

- ▶▶ Enabled Enable USB device function Support.
- ▶▶ Disabled Disable USB device function Support. (Default value)

☞ **USB Keyboard Support**

- ▶▶ Enabled Enable USB Keyboard Support. (Default value)
- ▶▶ Disabled Disable USB Keyboard Support.

☞ **USB Mouse Support**

- ▶▶ Enabled Enable USB Mouse Support.(Default value)
- ▶▶ Disabled Disable USB Mouse Support.

☞ **Onboard H/W LAN**

- ▶▶ Enabled Enable Onboard H/W LAN function. (Default value)
- ▶▶ Disabled Disable this function.

☞ **Onboard H/W 1394**

- ▶▶ Enabled Enable onboard IEEE 1394 function.(Default value)
- ▶▶ Disabled Disable this function.

☞ **Onboard Serial Port 1**

- ▶▶ Auto BIOS will automatically setup the port 1 address.
- ▶▶ 3F8/IRQ4 Enable onboard Serial port 1 and address is 3F8. (Default value)
- ▶▶ 2F8/IRQ3 Enable onboard Serial port 1 and address is 2F8.
- ▶▶ 3E8/IRQ4 Enable onboard Serial port 1 and address is 3E8.
- ▶▶ 2E8/IRQ3 Enable onboard Serial port 1 and address is 2E8.
- ▶▶ Disabled Disable onboard Serial port 1.

☞ **Onboard Parallel port**

- ▶▶ 378/IRQ7 Enable onboard LPT port and address is 378/IRQ7. (Default Value)
- ▶▶ 278/IRQ5 Enable onboard LPT port and address is 278/IRQ5.
- ▶▶ Disabled Disable onboard LPT port.
- ▶▶ 3BC/IRQ7 Enable onboard LPT port and address is 3BC/IRQ7.

☞ **Parallel Port Mode**

- ▶▶ SPP Using Parallel port as Standard Parallel Port.
- ▶▶ EPP Using Parallel port as Enhanced Parallel Port.
- ▶▶ ECP Using Parallel port as Extended Capabilities Port. (Default Value)
- ▶▶ ECP+EPP Using Parallel port as ECP & EPP mode.

Power Management Setup

CMOS Setup Utility-Copyright (C) 1984-2003 Award Software

Power Management Setup

ACPI Suspend Type	[S3(STR)]	Item Help
USB Device Wake-Up From S3	[Disabled]	Menu Level ►
Soft-Off by PWRBTN	[Instant-Off]	[S1]
AC BACK Function	[Memory]	Set suspend type to
Keyboard Power On	[Disabled]	Power On Suspend under
Mouse Power On	[Disabled]	ACPI OS
PME Event Wake Up	[Disabled]	
Modem Ring Resume	[Disabled]	[S3]
Resume by Alarm	[Disabled]	Set suspend type to
x Date (of Month) Alarm	Everyday	Suspend to RAM under
x Time (hh:mm:ss)	0 0 0	ACPI OS
↑↓→←: Move Enter:Select +/-/PU/PD:Value F10:Save ESC:Exit F1:General Help F5:Previous Values F6:Fail-Safe Defaults F7:Optimized Defaults		

Figure 5: Power Management Setup

☞ **ACPI Suspend Type**

- ▶▶ S1(POS) Set ACPI suspend type to S1.
- ▶▶ S3(STR) Set ACPI suspend type to S3. (Default Value)

☞ **USB Device Wake-up From S3**

When set at Enabled, it allows USB Device to activate the system from ACPI S3 power saving mode.

- ▶▶ Enabled Enable USB Device Wakeup.
- ▶▶ Disabled Disable USB Device Wakeup. (Default Value)

☞ **Soft-Off by PWRBTN**

- ▶▶ Instant-off Press power button then Power off instantly. (Default value)
- ▶▶ Delay 4 Sec. Press power button 4 sec to Power off. Enter suspend if button is pressed less than 4 sec.

☞ **AC BACK Function**

- ▶▶ Memory System power on depends on the status before AC lost. (Default value)
- ▶▶ Soft-Off Always in Off state when AC back.
- ▶▶ Full-On Always power on the system when AC back.

☞ **Keyboard Power On**

- ▶▶ Password Enter from 1 to 8 characters to set the Keyboard Power On Password.
- ▶▶ Disabled Disabled this function. (Default value)
- ▶▶ Keyboard 98 If your keyboard have "POWER Key" button, you can press the key to power on your system.

☞ **Mouse Power On**

- ▶▶ Disabled Disabled this function. (Default value)
- ▶▶ Enabled Double click on PS/2 mouse left button to power on system.

☞ **PME Event Wake Up**

- ▶▶ Disabled Disable this function. (Default Value)
- ▶▶ Enabled Enable PME Event Wake up.

☞ **Modem Ring Resume**

- ▶▶ Disabled Disable Modem Ring Resume function. (Default Value)
- ▶▶ Enabled Enable Modem Ring Resume function.

☞ **Resume by Alarm**

You can set "Resume by Alarm" item to enabled and key in Data/time to power on system.

- ▶▶ Disabled Disable this function. (Default Value)
- ▶▶ Enabled Enable alarm function to POWER ON system.

If RTC Alarm Lead To Power On is Enabled.

Date (of Month) Alarm : Everyday, 1-31

Time (hh: mm: ss) Alarm : (0-23) : (0-59) : (0-59)

PnP/PCI Configurations

CMOS Setup Utility-Copyright (C) 1984-2003 Award Software

PnP/PCI Configurations

PNP OS Installed	[Yes]	Item Help
PCI 1/PCI 5 IRQ Assignment	[Auto]	Menu Level ►
PCI 2 IRQ Assignment	[Auto]	Select Yes if you are
PCI 3 IRQ Assignment	[Auto]	using a Plug and Play
PCI 4 IRQ Assignment	[Auto]	capable operating
		system Select No if
		you need the BIOS to
		configure non-boot
		devices
↑↓→←: Move Enter:Select +/-/PU/PD:Value F10:Save ESC:Exit F1:General Help F5:Previous Values F6:Fail-Safe Defaults F7:Optimized Defaults		

Figure 6: PnP/PCI Configurations

☞ PNP OS Installed

- ▶▶ Yes Select Yes if you are using a Plug and Play capable operating system.
(Default value)
- ▶▶ No Select No if you need the BIOS to configure non-boot devices.

☞ PCI 1/PCI 5 IRQ Assignment

- ▶▶ Auto Auto assign IRQ to PCI 1/PCI 5. (Default value)
- ▶▶ 3,4,5,7,9,10,11,12,14,15 Set IRQ 3,4,5,7,9,10,11,12,14,15 to PCI 1/PCI 5.

☞ PCI 2 IRQ Assignment

- ▶▶ Auto Auto assign IRQ to PCI 2. (Default value)
- ▶▶ 3,4,5,7,9,10,11,12,14,15 Set IRQ 3,4,5,7,9,10,11,12,14,15 to PCI 2.

☞ PCI 3 IRQ Assignment

- ▶▶ Auto Auto assign IRQ to PCI 3. (Default value)
- ▶▶ 3,4,5,7,9,10,11,12,14,15 Set IRQ 3,4,5,7,9,10,11,12,14,15 to PCI 3.

☞ PCI 4 IRQ Assignment

- ▶▶ Auto Auto assign IRQ to PCI 4. (Default value)
- ▶▶ 3,4,5,7,9,10,11,12,14,15 Set IRQ 3,4,5,7,9,10,11,12,14,15 to PCI 4.

PC Health Status

CMOS Setup Utility-Copyright (C) 1984-2003 Award Software

PC Health Status

Vcore	1.74V	Item Help
+3.3V	3.28V	Menu Level ►
+5V	5.107V	
+12V	11.668V	
5VSB	4.919V	
Current System Temperature	32°C	
Current CPU Temperature	40°C	
Current CPU FAN Speed	6490 RPM	
Current SYSTEM FAN Speed	0 RPM	
Current POWER FAN Speed	0 RPM	
↑↓→←: Move Enter:Select +/-/PU/PD:Value F10:Save ESC:Exit F1:General Help F5:Previous Values F6:Fail-Safe Defaults F7:Optimized Defaults		

Figure 7: PC Health Status

☞ **Current Voltage (V) Vcore / +3.3V / +5V / +12V /5VSB**

►► Detect system's voltage status automatically.

☞ **Current System/CPU Temperature**

►► Detect System/CPU Temp. automatically.

☞ **Current CPU/SYSTEM/POWER FAN Speed (RPM)**

►► Detect CPU/SYSTEM/POWER Fan speed status automatically.

Frequency/Voltage Control

CMOS Setup Utility-Copyright (C) 1984-2003 Award Software

Frequency/Voltage Control

DRAM Clock (MHz)	[Auto]	Item Help
		Menu Level ►
<p>↑↓→←: Move Enter:Select +/-/PU/PD:Value F10:Save ESC:Exit F1:General Help F5:Previous Values F6:Fail-Safe Defaults F7:Optimized Defaults</p>		

Figure 8: Frequency/Voltage Control

⚙️ DRAM Clock (MHz)

►► Please set DRAM Clock according to your requirement.

If you use DDR266 DRAM module, please set "DRAM Clock(MHz)" to Auto or 266. If you use DDR333 DRAM module, please set "DRAM Clock(MHz)" to Auto or 333.

Incorrect using it may cause your system broken. For power End-User use only!

Load Fail-Safe Defaults

CMOS Setup Utility-Copyright (C) 1984-2003 Award Software

▶Standard CMOS Features	Load Fail-Safe Defaults
▶Advanced BIOS Features	Load Optimized Defaults
▶Integrated Peripherals	Set Supervisor Password
▶Power Management Setup	Set User Password
▶PnP/PCI	
▶PC Health	Load Fail-Safe Defaults? (Y/N)?Y
▶Frequency/Voltage Control	
ESC:Quit	↑↓→←:Select Item
F8: Q-Flash	F10:Save & Exit Setup
Load Fail-Safe Defaults	

Figure 9: Load Fail-Safe Defaults

Load Fail-Safe Defaults

Fail-Safe defaults contain the most appropriate values of the system parameters that allow minimum system performance.

Load Optimized Defaults

CMOS Setup Utility-Copyright (C) 1984-2003 Award Software

▶Standard CMOS Features	Load Fail-Safe Defaults
▶Advanced BIOS Features	Load Optimized Defaults
▶Integrated Peripherals	Set Supervisor Password
▶Power Management Setup	Set User Password
▶PnP/PCI Configurations	Save & Exit Setup
▶PC Health Status	
▶Frequency/Voltage Control	
Load Optimized Defaults? (Y/N)?Y	
ESC:Quit	↑↓→←:Select Item
F8: Q-Flash	F10:Save & Exit Setup
Load Optimized Defaults	

Figure 10: Load Optimized Defaults

Load Optimized Defaults

Selecting this field loads the factory defaults for BIOS and Chipset Features which the system automatically detects.

Set Supervisor/User Password

CMOS Setup Utility-Copyright (C) 1984-2003 Award Software

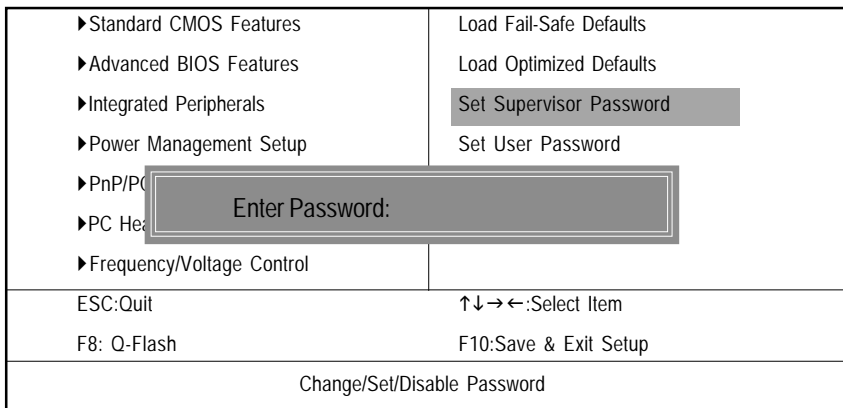

Figure 11: Password Setting

When you select this function, the following message will appear at the center of the screen to assist you in creating a password.

Type the password, up to eight characters, and press <Enter>. You will be asked to confirm the password. Type the password again and press <Enter>. You may also press <Esc> to abort the selection and not enter a password.

To disable password, just press <Enter> when you are prompted to enter password. A message "PASSWORD DISABLED" will appear to confirm the password being disabled. Once the password is disabled, the system will boot and you can enter Setup freely.

The BIOS Setup program allows you to specify two separate passwords:

SUPERVISOR PASSWORD and a USER PASSWORD. When disabled, anyone may access all BIOS Setup program function. When enabled, the Supervisor password is required for entering the BIOS Setup program and having full configuration fields, the User password is required to access only basic items.

If you select "System" at "Password Check" in Advance BIOS Features Menu, you will be prompted for the password every time the system is rebooted or any time you try to enter Setup Menu.

If you select "Setup" at "Password Check" in Advance BIOS Features Menu, you will be prompted only when you try to enter Setup.

Save & Exit Setup

CMOS Setup Utility-Copyright (C) 1984-2003 Award Software

▶Standard CMOS Features	Load Fail-Safe Defaults
▶Advanced BIOS Features	Load Optimized Defaults
▶Integrated Peripherals	Set Supervisor Password
▶Power Management Setup	Set User Password
▶PnP/PCI/Devices	Exit without Saving
▶PC Health Status	
▶Frequency/Voltage Control	
Save to CMOS and EXIT (Y/N)? Y	
ESC:Quit	↑↓→←:Select Item
F8: Q-Flash	F10:Save & Exit Setup
Save Data to CMOS	

Figure 12: Save & Exit Setup

Type "Y" will quit the Setup Utility and save the user setup value to RTC CMOS.

Type "N" will return to Setup Utility.

Exit Without Saving

CMOS Setup Utility-Copyright (C) 1984-2003 Award Software

▶Standard CMOS Features	Load Fail-Safe Defaults
▶Advanced BIOS Features	Load Optimized Defaults
▶Integrated Peripherals	Set Supervisor Password
▶Power Management Setup	Set User Password
▶PnP/PCI	Quit Without Saving (Y/N)? N
▶PC Health	
▶Frequency/Voltage Control	
ESC:Quit	↑↓→←:Select Item
F8: Q-Flash	F10:Save & Exit Setup
Abandon all Data	

Figure 13: Exit Without Saving

Type "Y" will quit the Setup Utility without saving to RTC CMOS.

Type "N" will return to Setup Utility.

